

PRESS BRAKE TOOLS FACTORY CATALOGUE

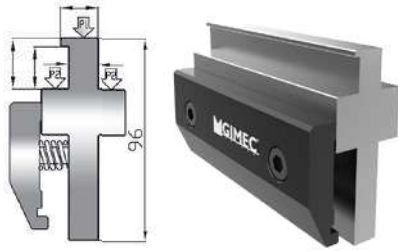

PL3 h96 + ST2

L mm 150



PL3 h126 + ST2

L mm 150

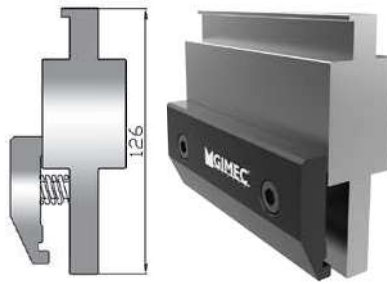

PL3 h156 + ST2

L mm 150

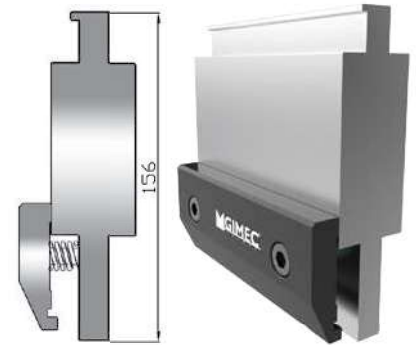

PL5 h100 + ST2

L mm 150

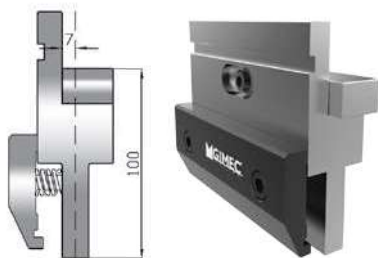

PL5 h120 + ST2

L mm 150

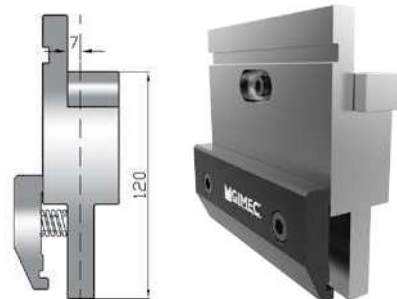

PL5 h150 + ST2

L mm 150



PL7 h120 + ST2

L mm 150

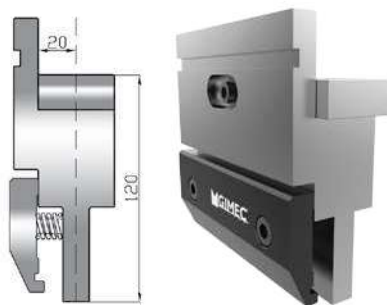

PL8 h100 + ST2

L mm 150

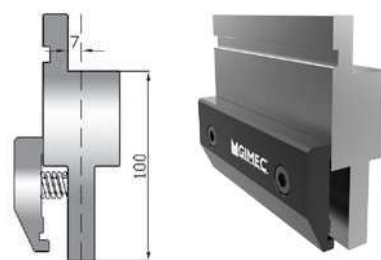

PL14 h60 + ST2 h mm 53

L mm 150

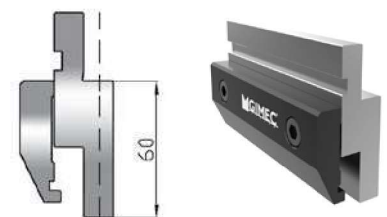

ST1

L mm 150

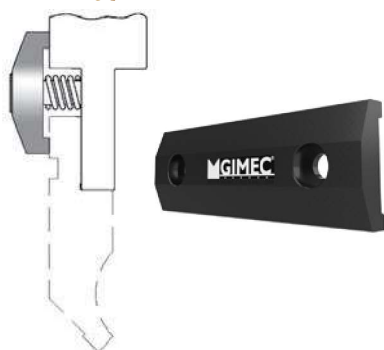

ST2

L mm 150

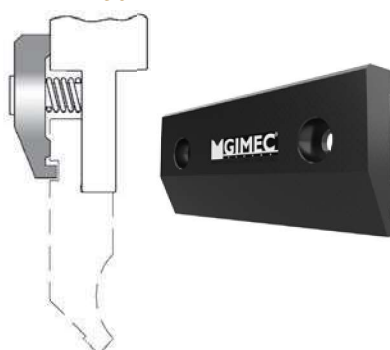

ST2 h mm 53

L mm 150



<p>ST2/L L mm 150</p>  <p>possono essere fornite con inserto in ADIPRENE /G can be supplied with ADIPRENE /G insert</p>	<p>ST2/X L mm 150</p> 	<p>KIT/ST2 h 60 mm</p> 	
------------------------------------------------------------------------------------------------------------------------------------------------------------------------------------------------------------------------	--------------------------------------------------------------------------------------------------------------------	------------------------------------------------------------------------------------------------------------------	--

<p>PL4 L mm 150 <i>Trumpf-Wila ▶ traditional</i></p> 	<p>PL6 L mm 150 <i>Trumpf-Wila ▶ Trumpf-Wila</i></p> 	<p>PL9 + ST2 L mm 150 <i>Trumpf-Wila ▶ Amada</i></p> 	
------------------------------------------------------------------------------------------------------------------------------------------------------	-------------------------------------------------------------------------------------------------------------------------------------------------------	---------------------------------------------------------------------------------------------------------------------------------------------------------	--

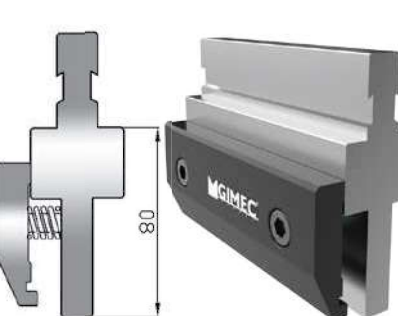
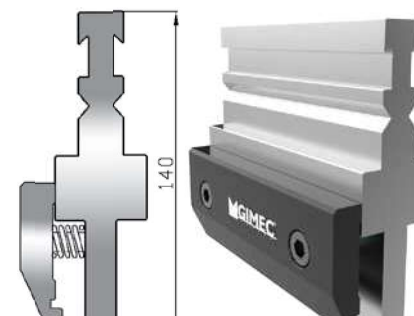
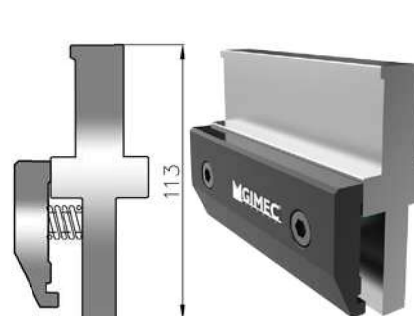
<p>PL10 + ST2 L mm 150 <i>COLGAR ▶ Amada</i></p> 	<p>PL11 + ST2 L mm 150 <i>Beyeler RFA ▶ Amada</i></p> 	<p>PL12 + ST2 L mm 150 <i>Beyeler S ▶ Amada</i></p> 	
---------------------------------------------------------------------------------------------------------------------------------------------------	---------------------------------------------------------------------------------------------------------------------------------------------------------	---------------------------------------------------------------------------------------------------------------------------------------------------------	--

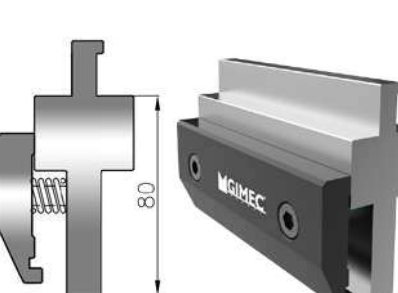
<p>PL13 + ST2 L mm 150 <i>LVD ▶ Amada</i></p> 	<p>PL16 L mm 150 <i>Amada ▶ Trumpf-Wila</i></p> 	<p>PL17 L mm 150 <i>Amada ▶ Trumpf-Wila</i></p> 	
------------------------------------------------------------------------------------------------------------------------------------------------	---------------------------------------------------------------------------------------------------------------------------------------------------	-----------------------------------------------------------------------------------------------------------------------------------------------------	--

PORTA UT

PM6

L mm 2100-2600-3100-4200

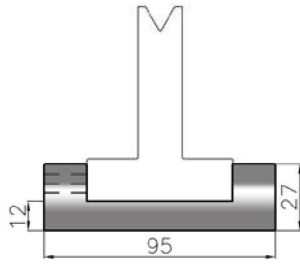

PM6 SHORT mm 60

L mm 520-1050

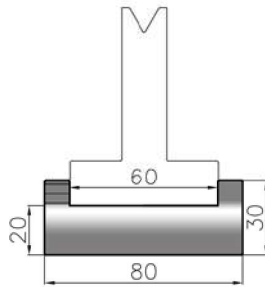

PM6 SHORT mm 60/90

L mm 520-1050

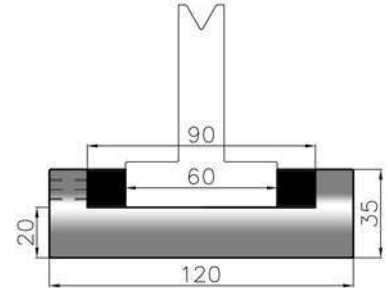

PM5

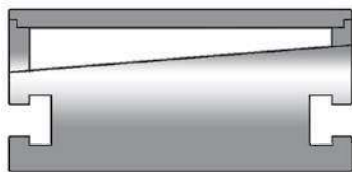

PM7

L mm 2100-2600-3100-4200

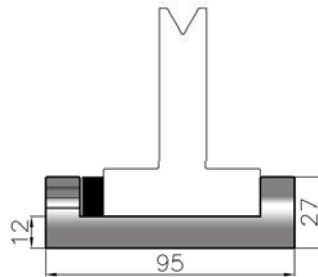

PM8

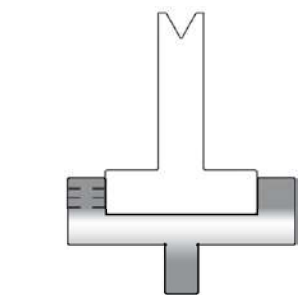

PM9 / T

L mm 835 - 415 Amada ▶ Trumpf-Wila

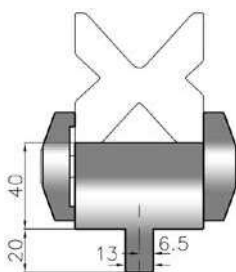

PM9 / L

L mm 835 - 415 Amada ▶ LVD

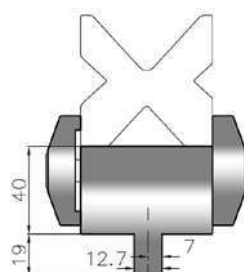

PM9 / 60

L mm 835 - 415

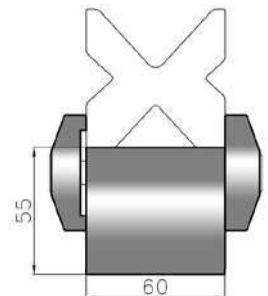

PM10 - h 30 - h 60 mm

L mm 500-1000

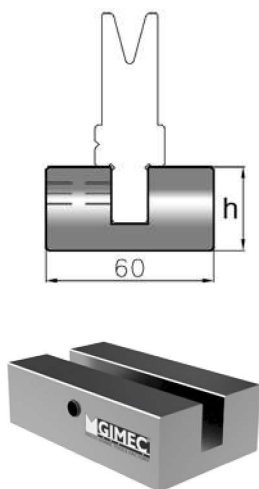

PM11

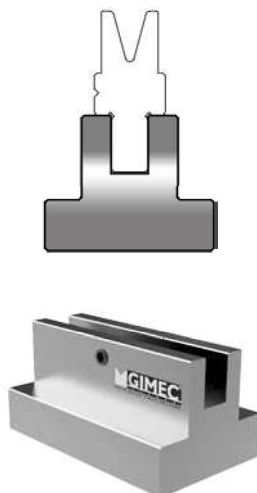

PM12



PM13

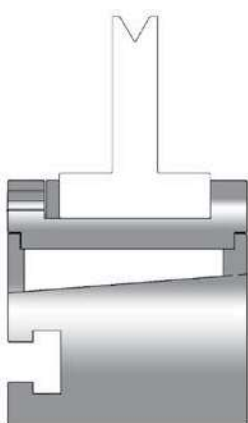

PM14

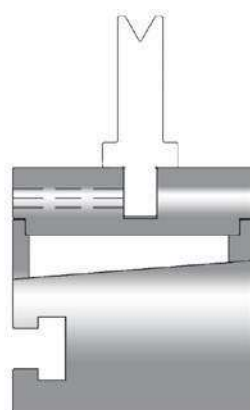

PM15

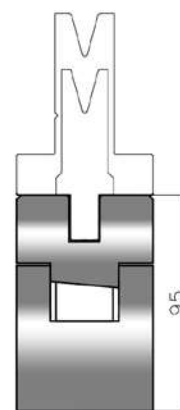

PORTA UT