

PRESS BRAKE TOOLS FACTORY CATALOGUE

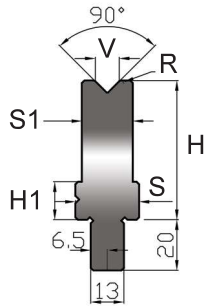

90°



codice articolo item code	V mm	R mm	H-H1 mm	S-S1 mm	max kN/mt
USB55 / 90° V06	6	0,4	55-15	25-15	1150
USB55 / 90° V08	8	0,5	55-15	25-15	1100
USB55 / 90° V10	10	1,0	55-15	25-20	1100
USB55 / 90° V12	12	1,5	55-15	25-20	1200
USB55 / 90° V16	16	2,0	55	30	1200

acciaio - steel 42CM4 T HRC 52+58 lunghezze - lengths mm 500 - 1000 - fraz 1100

88°

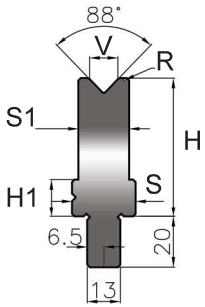

codice articolo item code	V mm	R mm	H-H1 mm	S-S1 mm	max kN/mt
USB55 / 88° V10	10	1,0	55-15	25-20	1100
USB55 / 88° V12	12	1,5	55-15	25-20	1200
USB55 / 88° V16	16	2,0	55	30	1200
USB55 / 88° V20	20	2,0	55	30	1100
USB55 / 88° V24	24	3,0	55	40	1200

acciaio - steel 42CM4 T HRC 52+58 lunghezze - lengths mm 500 - 1000 - fraz 1100

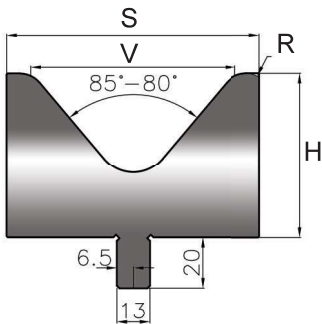

85° 80°



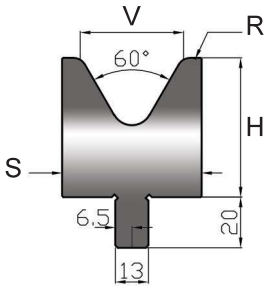

codice articolo item code	V mm	R mm	H mm	S mm	max kN/mt
USB55 / 85° V32	32	4,0	55	50	1200
USB55 / 85° V40	40	4,0	55	55	1200
USB55 / 80° V80	80	10,0	65	100	1700
USB85 / 80° V100	100	12,0	85	125	2300

acciaio - steel 42CM4 T HRC 52+58 lunghezze - lengths mm 500 - 1000 - fraz 1100

STANDARD TOOLS serie 13 USB®

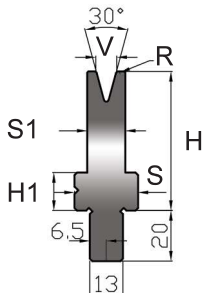
60°		codice articolo item code	V mm	R mm	H mm	S mm	max kN/mt
		USB55 / 60° V40	40	5,0	55	55	1300
		USB55 / 60° V50	50	5,0	55	70	1200
		USB65 / 60° V60	60	7,0	65	80	1100
acciaio - steel		42CM4 T HRC 52+58		lunghezze - lengths		mm 500 - 1000 - fraz 1100	

30°		codice articolo item code	V mm	R mm	H-H1 mm	S-S1 mm	max kN/mt
		USB55 / 30° V06	6	0,6	55-15	25-15	350
		USB55 / 30° V08	8	0,8	55-15	25-15	200
		USB70 / 30° V08	8	0,7	70-15	25-20	200
		USB55 / 30° V10	10	1,0	55-15	25-20	350
		USB70 / 30° V10	10	1,0	70-15	25-20	350
		USB55 / 30° V12	12	1,5	55-15	25-20	300
		USB70 / 30° V12	12	1,5	70	25-25	300
		USB55 / 30° V16	16	2,0	55	30	450
		USB70 / 30° V16	16	2,0	70	30	450
		USB55 / 30° V20	20	2,5	55	35	500
		USB55 / 30° V24	24	3,0	55	40	550
		USB60 / 30° V32	32	4,0	60	60	650
acciaio - steel		42CM4 T HRC 52+58		lunghezze - lengths		mm 500 - 1000 - fraz 1100	

LUNGHEZZE • LENGTHS
 mm 500 - 1000 - fraz 1100 mm 10+15+20+30+40+50+60+75+100+100+200+400

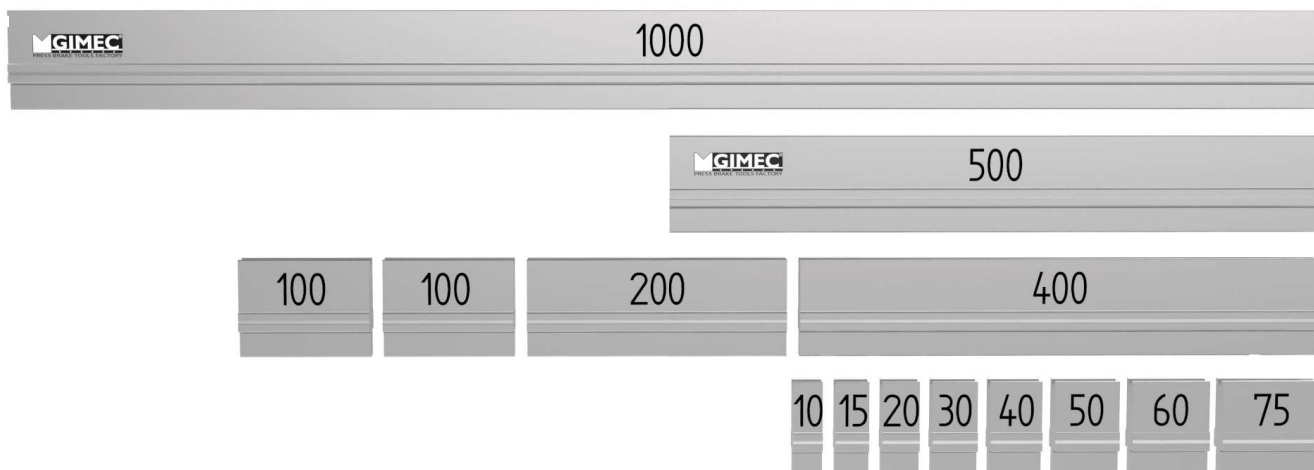

STANDARD TOOLS
serie 13 USB®