









# ROSENFORS

MADE IN SWEDEN

## Rosenfors 25

			50Hz	60Hz
				Ø 25 / 28 mm
	130 mm		0,65kW	0,80kW
	M16 / M20			
	MK 3			
	500 x 400 mm			



185

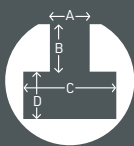

A: 14,5 +/- 0,8 mm  
 B: 13 mm  
 C: 26 mm  
 D: 12 mm

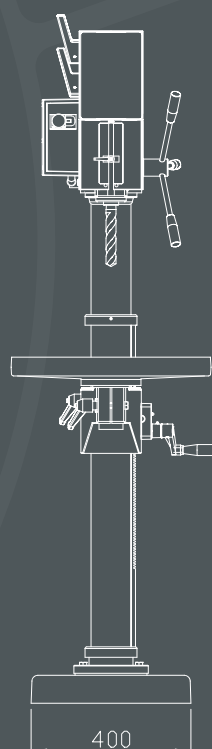
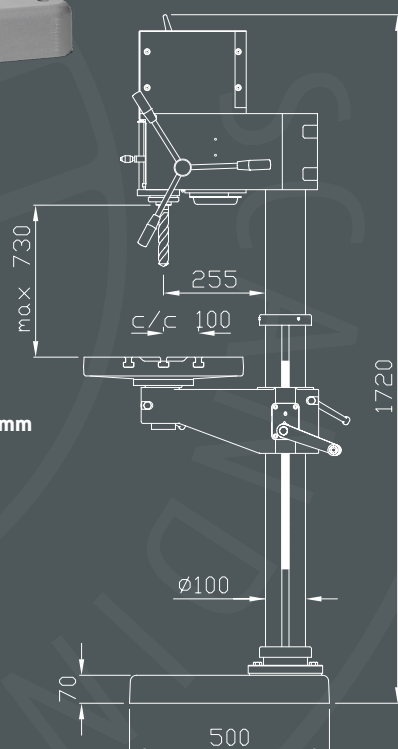

Rätt till ändringar av tekniska data utan förgående meddelande förbehålles.

We reserve the right to make modifications without prior warning.

Das recht auf Änderung der vorstehenden Daten behalten wir uns vor.

**msc**  
 machinery scandinavia  
 MADE IN SWEDEN



**ROSENFORS**  
MADE IN SWEDEN

# Tillbehör Rosenfors 25

SPARE PARTS/ZUBEHÖR



**Verktygspaket**  
T25000



**Anslutningskabel**  
T25006



**Borrchuck med dorn**  
T30040 0 - 13 mm



**Borrchuck med dorn**  
T30041 3 - 16 mm



**MSK belysning**  
T25005

**Borrexempel:**  
**Stål/Gjutjärn**

Ø	Varvtal/rpm
0 - 4 mm	1498 rpm
5 - 11 mm	558 rpm
12 - 17,5 mm	346 rpm
17,6 - 25 mm	129 rpm

**Drilling example:**  
**Steel/Cast iron**

Ø	Rotation speed/rpm
0 - 4 mm	1498 rpm
5 - 11 mm	558 rpm
12 - 17,5 mm	346 rpm
17,6 - 25 mm	129 rpm

**Bohrbeispiel:**  
**Stahl/Gusseisen**

Ø	Drehzahl/rpm
0 - 4 mm	1498 rpm
5 - 11 mm	558 rpm
12 - 17,5 mm	346 rpm
17,6 - 25 mm	129 rpm